

Urologie
Urology
Urología
Urologie
Urologia

31

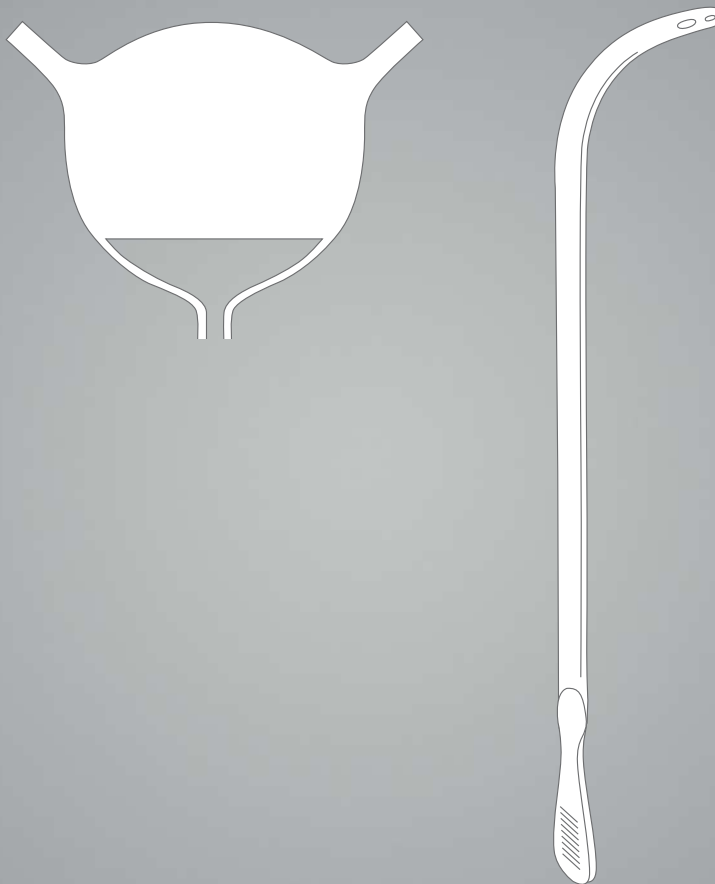

Nierensteinzangen

Kidney Stone Forceps

Pinzas para cálculos renales

Pinces pour les calculs du bassinet

Pinze per calcoli renali



1/2

Randall
31-101-23-07 -
31-107-22-07

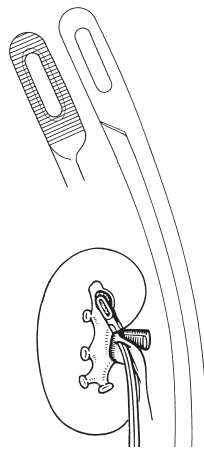

1/1

Fig. 1
31-101-23-07
23 cm / 9"

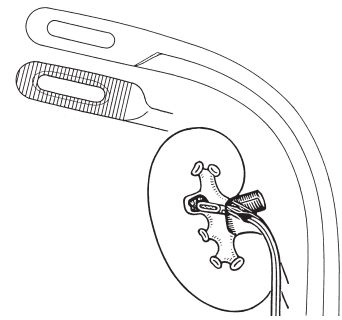

Fig. 2
31-103-22-07
21 cm / 8 2/8"

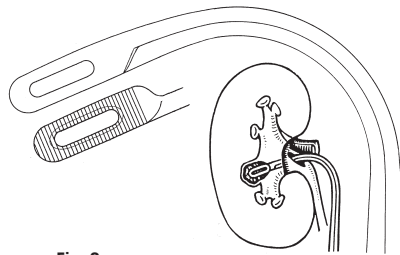

Fig. 3
31-105-22-07
19 cm / 7 4/8"

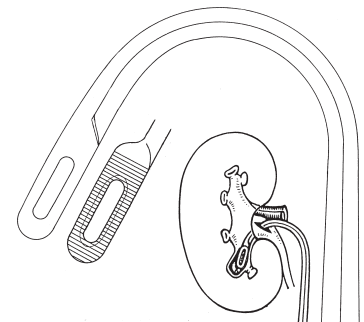

Fig. 4
31-107-22-07
18,5 cm / 7 2/8"



1/2

Heiming
31-113-16-07 -
31-113-17-07

für Kinder
for children
para niños
pour enfants
per bambini

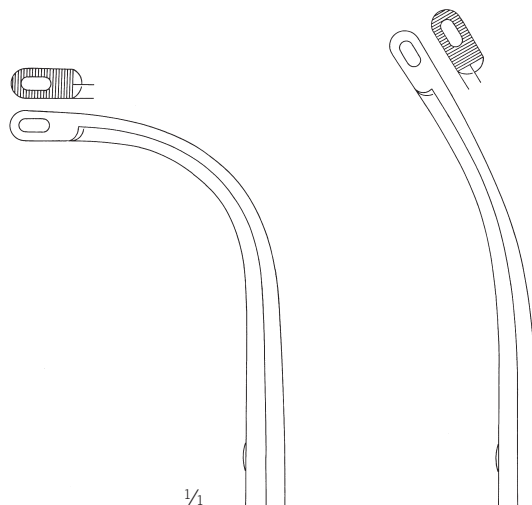

1/1

Fig. 1
31-113-16-07
16 cm / 6 2/8"

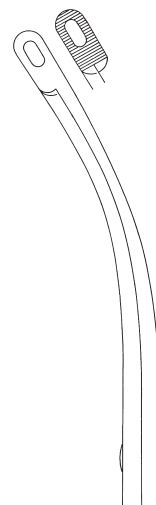

Fig. 2
31-113-17-07
17 cm / 6 6/8"

Gallenkanaldilatatoren

Gall Duct Dilators
 Dilatadores para conducto biliar
 Dilatateurs pour les voies biliaires
 Dilatatori per condotti biliari

Urologie

Urology
 Urología
 Urologie
 Urologia

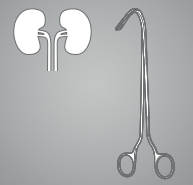

31



Fig. 1	Fig. 2	Fig. 3	Fig. 4
∅ 1,0 mm	∅ 2,0 mm	∅ 3,0 mm	∅ 4,0 mm
31-170-01-01	31-170-02-01	31-170-03-01	31-170-04-01

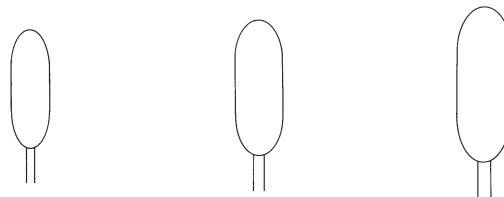

Fig. 5	Fig. 6	Fig. 7
∅ 5,0 mm	∅ 6,0 mm	∅ 7,0 mm
31-170-05-01	31-170-06-01	31-170-07-01

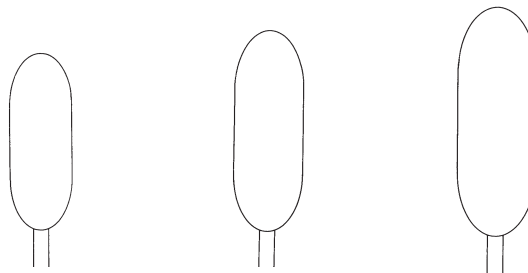

Fig. 8	Fig. 9	Fig. 10
∅ 8,0 mm	∅ 9,0 mm	∅ 10 mm
31-170-08-01	31-170-09-01	31-170-10-01

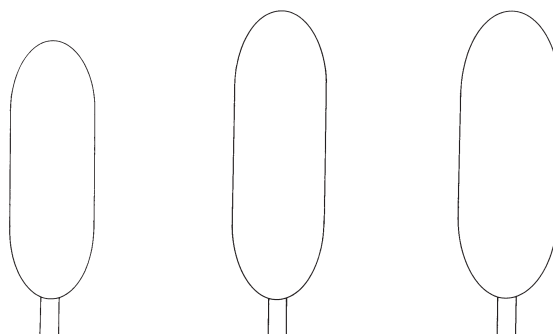

Fig. 11	Fig. 12	Fig. 13
∅ 11 mm	∅ 12 mm	∅ 13 mm
31-170-11-01	31-170-12-01	31-170-13-01



1/2

Bakes
 31-170-01-01 -
 31-170-13-01

32 cm / 12 5/8"
 biegsamer Schaft
 malleable shaft
 vástago maleable
 tige malléable
 gambo malleabile

Gallensteinzangen

Gall Stone Forceps

Pinzas para cálculos biliares

Pinces pour calculs biliaires

Pinze per calcoli biliari

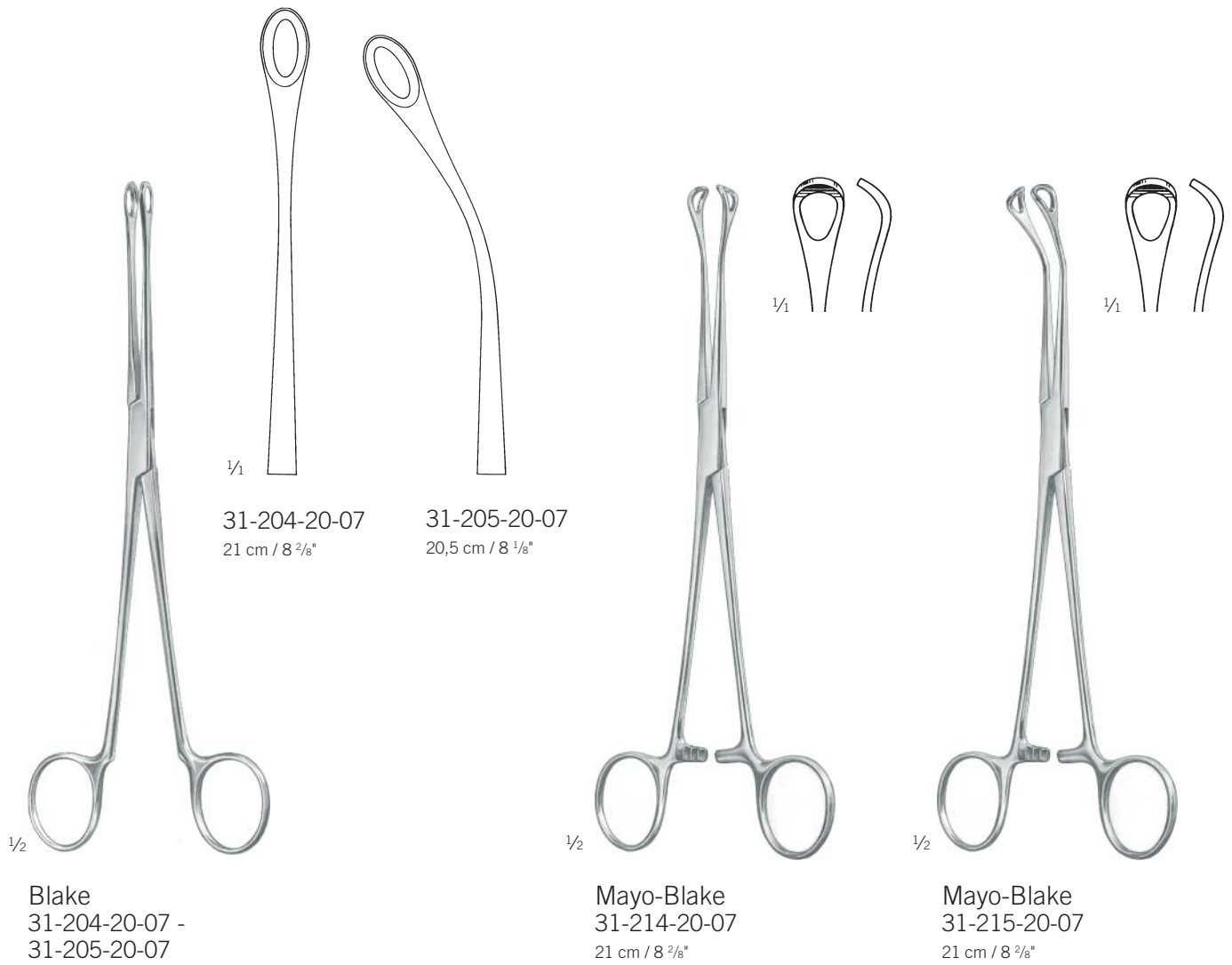

Gallensteinzangen

Gall Stone Forceps

Pinzas para cálculos biliares

Pinces pour calculs biliaires

Pinze per calcoli biliari

Urologie

Urology

Urología

Urologie

Urologia

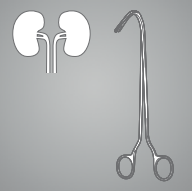

Mixer
31-217-22-07
22 cm / 8 5/8"



Desjardins
31-223-23-07 -
31-225-23-07
23 cm / 9"

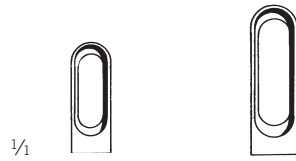

Fig. 1
31-223-23-07

Fig. 2
31-225-23-07



Desjardins
31-226-25-07
22,5 cm / 8 7/8"

Gallensteinlöffel

Gall Stone Scoops

Cucharas para cálculos biliares

Curettes pour calculs biliaires

Pinze per calcoli biliari



Fig. 000	Fig. 00	Fig. 0	Fig. 1
2,7 mm	3,4 mm	4,3 mm	5,5 mm
31-340-01-07	31-340-02-07	31-340-03-07	31-340-04-07



Fig. 2	Fig. 3	Fig. 4	Fig. 5
6,6 mm	8 mm	11 mm	15 mm
31-340-05-07	31-340-06-07	31-340-07-07	31-340-08-07

1/2

Luer-Körte

31-340-01-07 -

31-340-08-07

32 cm / 12 5/8"

biegsamer Schaft, stumpf

malleable shaft, blunt

vástago maleable, romo

tige malléable, mousse

gambo malleabile, smusso

Prostatahaken

Prostatic Retractors
Separadores para próstata
Ecarteurs prostatiques
Divaricatori prostatici

Urologie

Urology
Urología
Urologie
Urologia

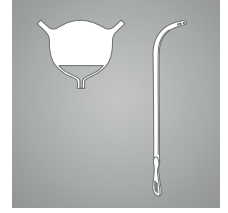

31

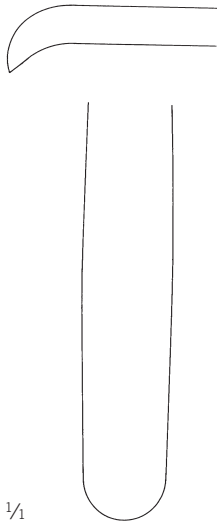

1/1

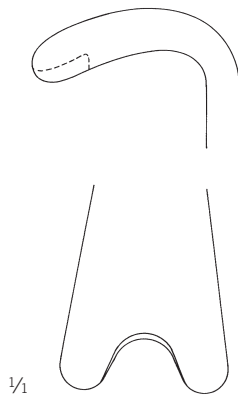

1/1

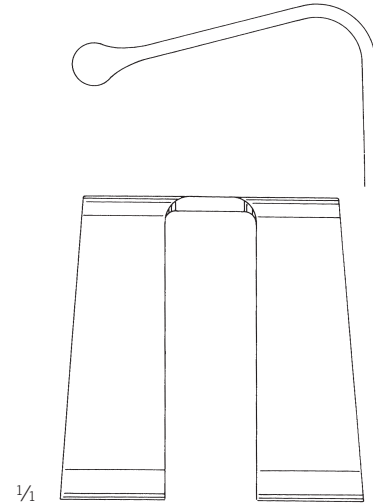

1/1



1/2

12,5 mm
Young
31-401-21-07
22 cm / 8 5/8"



1/2

24 mm
Young
31-405-21-07
22 cm / 8 4/8"



1/2

41 mm
Young
31-407-22-07
23 cm / 9"

Kapselfasszangen

Capsule Forceps

Pinzas capsulares

Pinces pour saisir les capsules

Pinze per afferrare capsule

Atrauma



Millin
31-451-24-07
24,5 cm / 9 5/8"

Atrauma



Millin
31-453-24-07
22,5 cm / 8 7/8"



Millin
31-461-23-07
24,5 cm / 9 5/8"

Kapselfasszange, Fadenführungszange

Capsule Forceps, Ligature Carrying Forceps

Pinzas capsulares, Pinza porta ligaduras

Pinces pour saisir les capsules, Pince porte-fil

Pinze per afferrare capsule, Pinza porta-filo

Urologie

Urology

Urología

Urologie

Urologia

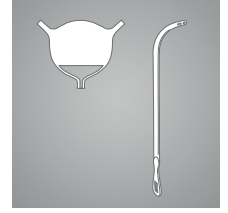

1/2

Millin
31-463-23-07
22 cm / 8 5/8"



1/2

Millin
31-465-24-07
24 cm / 9 4/8"

Blasenhalsperrer, Blasenwundsperrer

Bladder Neck Spreader, Bladder Retractors

Dilatador para el cuello vesical, Separadores vesicales

Ecarteur pour le col de la vessie, Ecarteurs vésicaux

Divaricatore del collo vescicale/Divaricatore vescicale



1/2

Millin
31-475-00-07
28 cm / 11"



70 mm



1/2

Judd-Masson
31-510-00-07



120 mm

Blasenwundsperrer

Bladder Retractors
Separadores vesicales
Ecarteurs vésicaux
Divaricatore vescicale

Urologie

Urology
Urología
Urologie
Urologia

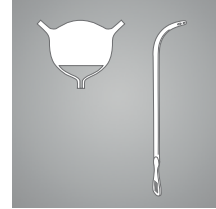

31



1/2

Millin

31-512-00-07

komplett, mit je 2 Seitenvalven
57 x 25 mm und 80 x 25 mm, sowie
einer 1 Mittelvalve 120 x 45 mm

complete, with 2 pairs of lateral
blades 57 x 25 mm and 80 x 25 mm,
and 1 central blade 120 x 45 mm

completo, con 2 pares de valvas
laterales 57 x 25 mm y 80 x 25 mm y
una valva central 120 x 45 mm,

complet, avec 2 paires de valvas
latérales 57 x 25 mm et 80 x 25 mm
et 1 valve centrale 120 x 45 mm,

completo, con 2 paia di valve laterali
57 x 25 mm e 80 x 25 mm in più 1
valva centrale 120 x 45 mm,



57 x 25 mm

31-512-90-98

Seitenvalven
Lateral Blades
Valvas laterales
Valves laterales
Valve laterali



80 x 25 mm

31-512-91-98

Seitenvalven
Lateral Blades
Valvas laterales
Valves laterales
Valve laterali

120 x 45 mm

31-512-92-98

Mittelvalve
Central Blade
Valva central
Valve centrale
Valva centrale

Harnröhrenbougies

Urethral Sounds

Bujías uretrales

Bougies urétrales

Candelette dilatatrici

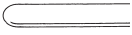
1/1 

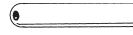
1/1 



Charrière	Van Buren
8	31-599-08-07
10	31-599-10-07
12	31-599-12-07
14	31-599-14-07
16	31-599-16-07
18	31-599-18-07
20	31-599-20-07
22	31-599-22-07
24	31-599-24-07
26	31-599-26-07
28	31-599-28-07
30	31-599-30-07
32	31-599-32-07
34	31-599-34-07
36	31-599-36-07



Charrière	Guyon
10	31-607-10-07
11	31-607-11-07
12	31-607-12-07
13	31-607-13-07
14	31-607-14-07
15	31-607-15-07
16	31-607-16-07
17	31-607-17-07
18	31-607-18-07
19	31-607-19-07
20	31-607-20-07
21	31-607-21-07
22	31-607-22-07
23	31-607-23-07
24	31-607-24-07
25	31-607-25-07
26	31-607-26-07
27	31-607-27-07
28	31-607-28-07
29	31-607-29-07
30	31-607-30-07

1/2

1/2

Van Buren
31-599-00-07 -
31-599-36-07
27 cm / 10 5/8"

31-599-00-07
Satz komplett, 8 - 36 Charrière
complete set, 8 - 36 Charrière
juego completo, 8 - 36 Charrière
jeu complet, 8 - 36 Charrière
set completo, 8 - 36 Charrière

Guyon
31-607-10-07 -
31-607-30-07
26,5 cm / 10 3/8"

Katheter

Catheters
Sondas
Sondes
Sonde

Urologie

Urology
Urología
Urologie
Urologia

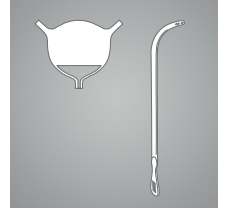

Charrière	
13	31-721-12-01
15	31-721-14-01



1/2

31-721-12-01 -
31-721-14-01

15 cm / 5 7/8"

Metallkatheter für Frauen
Metal Catheters, female
Sondas metálicas, femeninas
Sondes métalliques, pour femmes
Sonde metalliche, per donne

Urethrotom

Urethrotome

Uretrótopo

Urétrótome

Uretrotomi

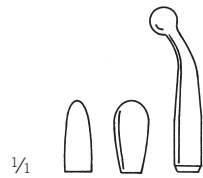

1/1

31-740-90-98

3 Ansätze allein
3 tips only
3 puntas suelta
3 embouts seul
3 punte solo



Otis

31-740-00-07

komplett im Holzetui, mit Dilatator, 2 Messern und 3 Ansätzen
complete in wooden case, with dilator, 2 knives and 3 tips
completo en caja de madera, con dilatador, 2 cuchillos y 3 puntas
complet en boîte de bois, avec dilataleur, 2 lames et 3 embouts
completo in contenitore di legno, con dilatatore, 2 bisturi e 3 punte



1/2



1/2

Otis

31-745-00-07

Ersatzmesser
Spare Blade
Cuchillo de repuesto
Couteau de rechange
Lama di ricambio



31-740-00-07

Urethrographie- u. Circumcisions-Instrumente

Urethrography- and Circumcision Instruments
Instrumentos para uretrografía y circuncisión
Instruments pour uréthrographie et circoncision
Strumenti per uretrografia e circoncisione

Urologie

Urology
Urología
Urologie
Urologia

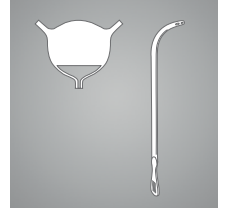

31



1/2

Knutson
31-760-00-07

Urethrographieinstrument
Urethrography Instrument
Instrumento para uretrografía
Instrument pour uréthrographie
Strumento per uretrografia



1/2

Knutson-Koch
31-763-00-04

Konus, allein
Cone, only
Cono, suelto
Cône, seul
Cono, solo



31-760-00-07



1/2

31-765-08-07 -
31-765-32-07

Circumcisionsgerät
Circumcision Instrument
Instrumento para circuncisión
Instrument de circoncision
Strumento per circoncisione

	∅
31-765-08-07	8 mm
31-765-11-07	11 mm
31-765-13-07	13 mm
31-765-16-07	16 mm
31-765-21-07	21 mm
31-765-26-07	26 mm
31-765-32-07	32 mm



1/2

Mogen
31-766-00-07

7,5 cm / 3 "

Beschneidungsinstrument
Circumcision Instrument
Instrumento para circuncisión
Instrument de circoncision
Strumento per circoncisione

Fremdkörperzangen

Foreign Body Forceps

Pinzas para cuerpos extraños

Pinces pour corps étrangers

Pinze per corpi estranei

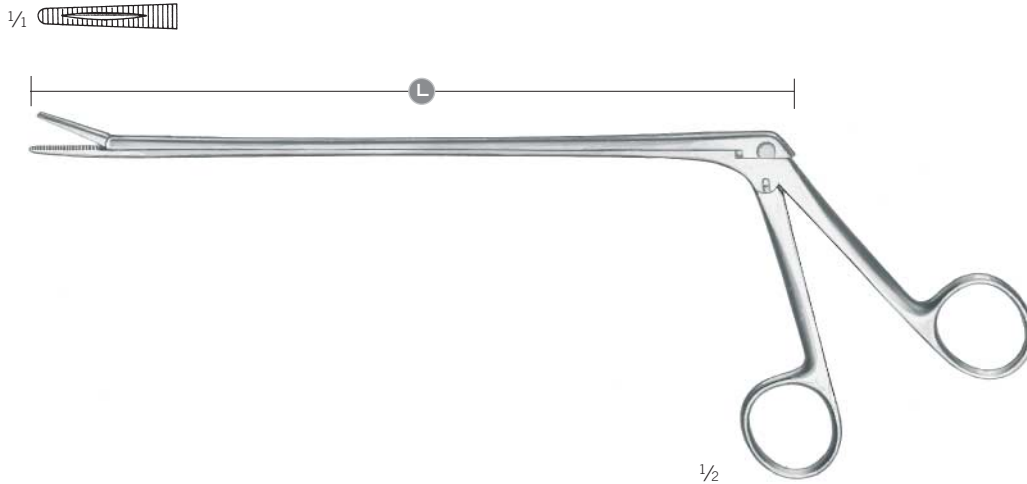

Mathieu
31-811-20-07

Schaftlänge
shaft length
longitud del vástago
longueur de la tige
lunghezza dell'asta

200 mm

Mathieu
31-811-28-07

Schaftlänge
shaft length
longitud del vástago
longueur de la tige
lunghezza dell'asta

300 mm

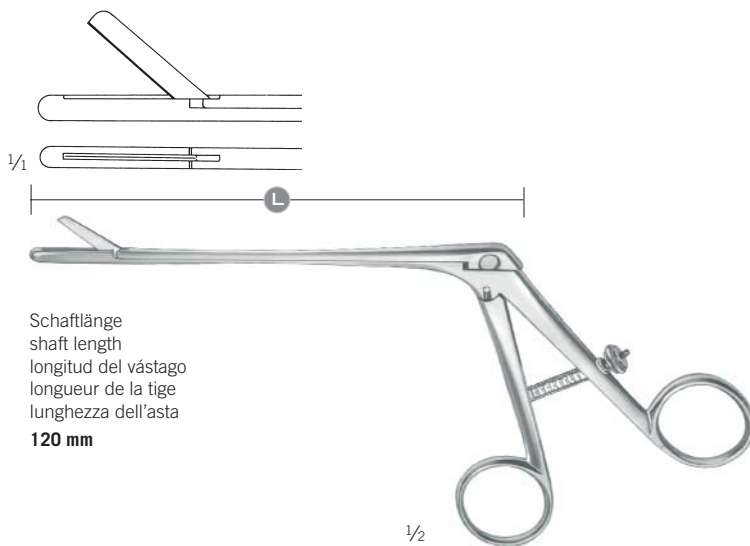

Schaftlänge
shaft length
longitud del vástago
longueur de la tige
lunghezza dell'asta

120 mm

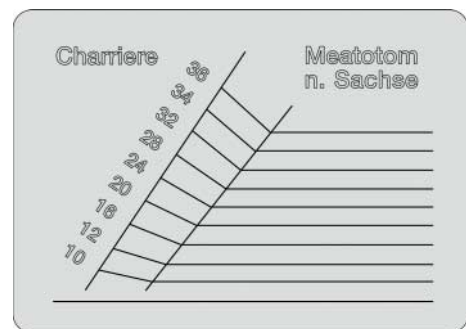

Sachse
31-817-12-07

Meatotom
Meatotome
Meatotómo
Méatotome
Meatotomo

Sachse
31-817-00-01

Messlehre
Gauge
Calibre
Calibre
Calibro



31-817-12-07

Penisklemmen

Penis Clamps
Clamps para pene
Pinces pour pénis
Serrapene

Urologie

Urology
Urología
Urologie
Urologia

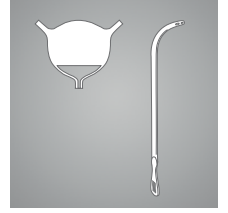

1/2

Stockmann
31-875-08-01
8 cm / 3 1/8"



1/2

Strauss
31-881-11-01
11 cm / 4 3/8"

31-881-90-98

1 Paar Schläuche allein
1 pair of flexible tubes only
1 par de mangueras individuales
1 paire de tubes flexibles, seuls
1 coppia di tubi flessibili singoli